

Extend the Renault Master Z.E. experience
on www.renault.country

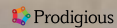

Every precaution was taken to ensure this publication was accurate and up-to-date when printed. This document has been created using pre-production and prototype models. In line with its policy of continuous product improvement, Renault reserves the right to modify the specifications, vehicles and accessories described and featured at any time. Any such changes are communicated to Renault dealers as quickly as possible. Depending on the country of sale, certain versions may differ and certain equipment may be unavailable (as standard, on option or as an accessory). Please contact your nearest dealer for the latest information. For technical printing reasons, the colours featured in this document may differ slightly from those of the actual paintwork or interior trim. All rights reserved. Reproduction in any format and by any means of all or part of this publication is prohibited without prior written authorisation from Renault.

Renault recommends 

 Prodigious Photo credits: © Renault Marketing 3D-Commerce, T. Motta – Thanks to “TAM and Montpellier Méditerranée Métropole” – Printed in EC – xxxxxxxxxx – March 2018.

Renault S.A.S. French simplified joint-stock company with capital of €533,941,113.00 / 13-15, quai Le Gallo – 92100 Boulogne-Billancourt Cedex – Nanterre Trade & Companies Registry No. B 780 129 987 / Tel.: +33 (0)810 40 50 60.



RENAULT
PRO+

Renault MASTER Z.E.



Z.E.





The ideal partner
for deliveries in the heart of town



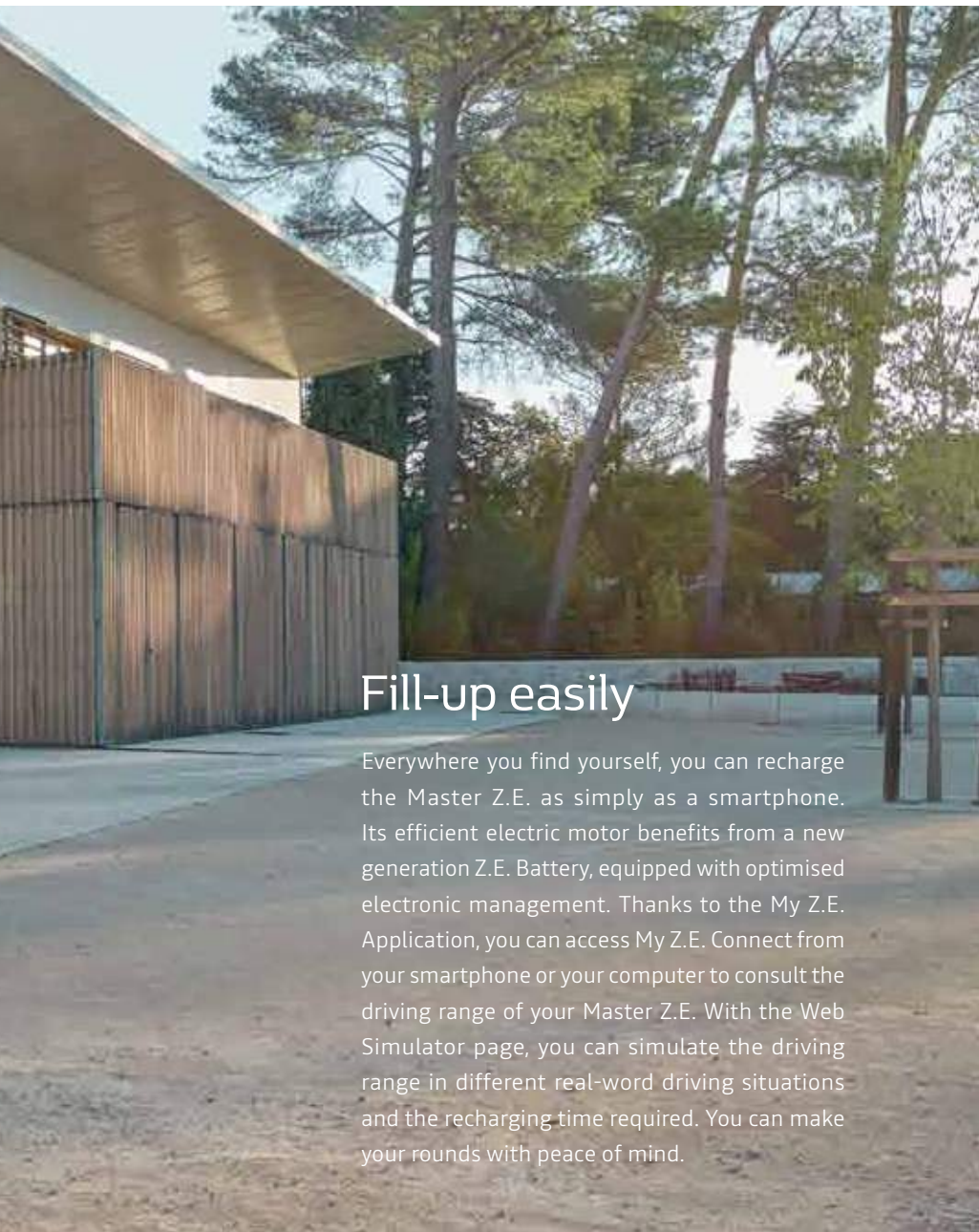

Fill-up easily

Everywhere you find yourself, you can recharge the Master Z.E. as simply as a smartphone. Its efficient electric motor benefits from a new generation Z.E. Battery, equipped with optimised electronic management. Thanks to the My Z.E. Application, you can access My Z.E. Connect from your smartphone or your computer to consult the driving range of your Master Z.E. With the Web Simulator page, you can simulate the driving range in different real-world driving situations and the recharging time required. You can make your rounds with peace of mind.

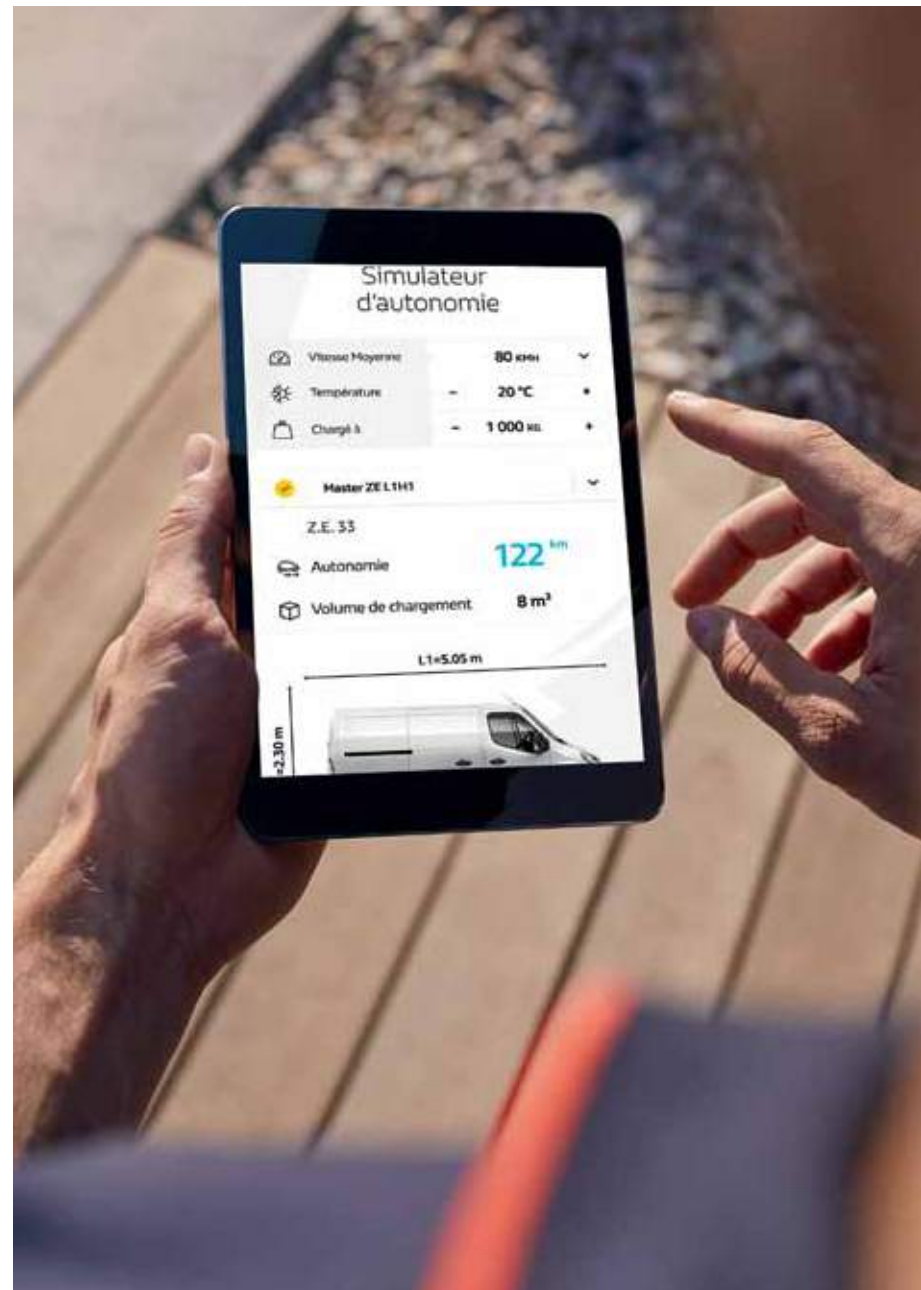

Your range is 100% controlled

Master Z.E. has a real-world range of 120 km⁽¹⁾. With Z.E. Trip⁽²⁾, accessed via the Renault multimedia R-LINK Evolution system, you can locate recharging terminals along your route and check their availability in real time. With the Z.E. Pass⁽³⁾, access as many recharging terminals as you need and pay with a single card or smartphone app. It's that simple.

1. Regenerative braking: the battery recharges when you take your foot off the accelerator or when you press on the brake pedal. **2. Low consumption tyres:** their low rolling resistance contributes to conserving your driving range without degrading your road-holding or braking ability. **3. Econometer:** situated on the dashboard, this instrument tells you if you are in a consumption or a regeneration phase. **4. Eco Mode:** when you activate this, you govern your motor so that you can travel farther (less abrupt acceleration and maximum speed of 80 km/h). **5. Connected services:** with My Z.E. Service⁽²⁾, consult the state of charge of your vehicle remotely. Be alerted on your computer or smartphone of the state of charge and the time remaining to arrive at 100%. **6. Thermal pre-conditioning:** program the heating or air-conditioning via dashboard controls while the vehicle is still being charged. The energy used will not drain your battery. **7. 7 kW charger:** recharge the battery in only 6h with a Wallbox 32 A / 7 kW. The recharging hatch situated on the right-hand side of the cab, is easily accessible.

(1) Real-world driving range greater than 80 km including the most severe use (high load, city centre driving with frequent stops, winter conditions). Actual consumption also depends on the equipment, the driving style of the driver and the elevation profile of the route. (2) Subscription services. (3) Developed by Bosch Software Innovations GmbH for Renault.

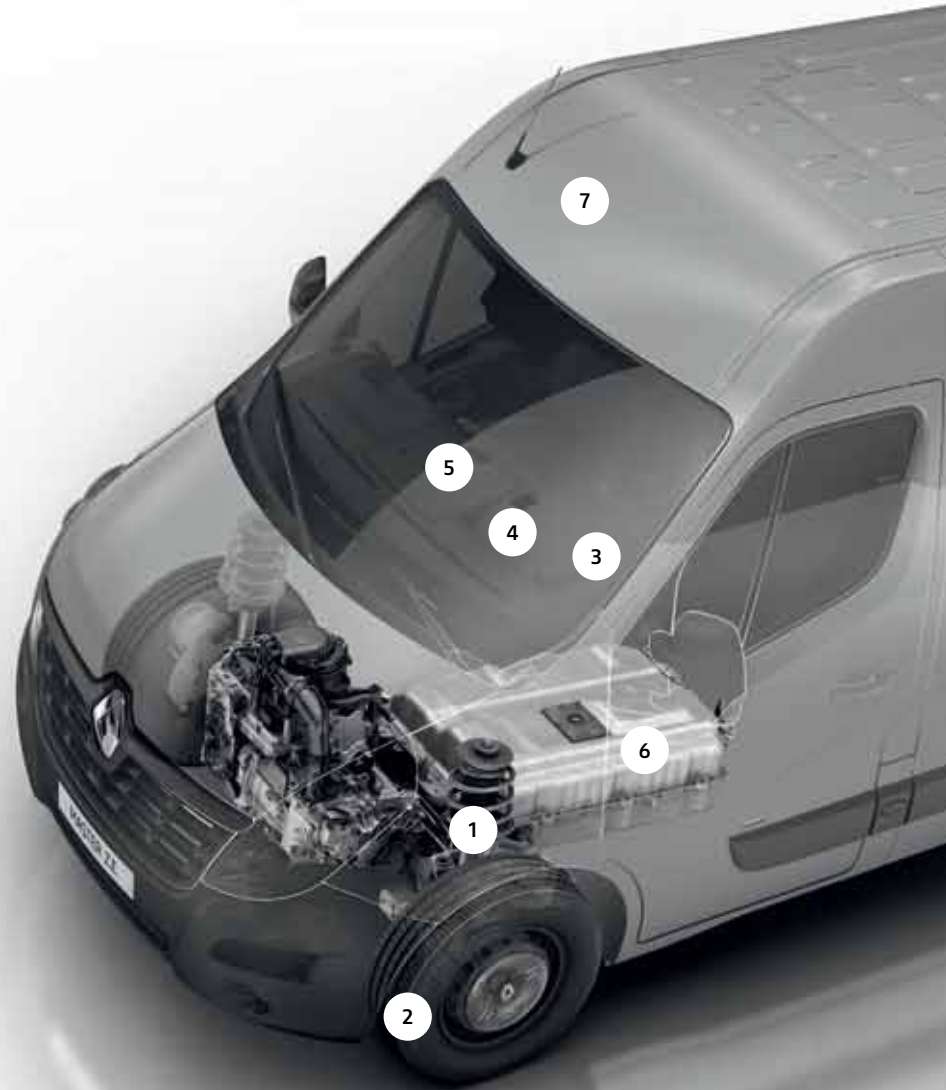







Tailor-made whatever your project.

Develop your business, nothing is stopping you with one of the 6 versions of Master Z.E. The 4 van versions offer you from 8 to 13m³ of loading volume, a payload of up to 1100 kg, a rear 270° opening and a sliding door: Everything to make loading and unloading easy. The 2 cab floor versions make a large number of transformations possible, including the Large Volume adaptation for loading up to 22 m³. Available in several configurations, Master Z.E. adapts to your needs and will be your ideal partner in the urban environment.





Your mobile, connected office

Designed down to the smallest detail, the interior environment of the Master Z.E. helps to boost your productivity. You can pull out the pivoting table and the document holder from the dashboard so you can have a real office. Simplify your city deliveries with your reversing camera and blind spot rear view mirror. With its 7" touchscreen, intuitive voice control and steering wheel-mounted controls, the Renault R-LINK Evolution multimedia system lets you access innovative, practical features, including TomTom navigation, multimedia, a telephone system and vehicle data. Thanks to LIVE services including TomTom Traffic,* get the best traffic information in real time. With Android Auto™**, you can access your smartphone's driving-compatible applications from the R-LINK Evolution screen.

* Depending on the country and for a limited period.

** Depending on the country; Android Auto™ is a trademark of Google Inc.





CARLAB Chromo Zone

Mineral White (CO)



Star Grey (M KNH)



Saviem Blue (CO 423)



Volga Blue (CO RNQ)



CO: clearcoat opaque
M: metallic
Photos not contractual

Pearl Black (PC 676)



Grey Blue (M J47)



Lemon Yellow (CO 396)



Orange (CO 031)



Magma Red (CO 719)



CARLAB Engines

	Van			Platform Cab		
	L1H1	L1H2	L2H2	L3H2	L2H1	L3H1
ENGINE						
Engine and traction chain	Synchronous with wound rotor					
Max. torque (nm) / Max. power (kW)	225/57					
Type of propulsion	Front-wheel drive					
PERFORMANCE						
Top speed (km/h)	100					
GEARBOX						
Type	Reduction gear					
Number of forward gears	1					
SHAFT						
Reduction ratio	9.3					
BATTERY						
Battery type	Lithium-ion					
Battery weight (kg)	255					
Capacity (kWh)	33					
Structure	48 modules / 192 cells					
Voltage (V)	400					
CHARGING						
Main charging	Wall-Box with standard charging cable (mode 3 type 2, 32 A, 7.4 kW) as standard					
Occasional charging	On domestic socket 220 V					

	Van				Platform Cab	
	L1H1	L1H2	L2H2	L3H2	L2H1	L3H1
CHARGING (CONTD.)						
Charging time	On Wall-Box 7.4 kW: 6 h On Wall-Box 3.7 kW: 11 h On domestic socket 2.3 kW: 17 h					
Location of charging outlet	Right-hand side on B pillar of vehicle (Close to front right-hand door opening)					
TYRES						
Tyre reference	CONTINENTAL Vanco Eco 215/65 R16C (Low rolling resistance tyre)					
Energy class / Adhesion / Noise	B/B/71 dB					
DRIVING RANGE						
NEDC* driving range (km)	193					
Actual driving range** (km)	120	120	120	120	According to transformation	
CO ₂ (g/km)	0					
LOADING						
Loading area volume (m ³)	8	9	10.8	13	According to transformation	
Max payload (kg)	1,128	1,100	1,056	975	1,377	1,355
	without transformation					

New European Driving Cycle, the European standard for measuring emissions and consumption, is a standardised method for measuring consumption based on identical tests carried out on all types of vehicles in Europe whether they use combustion, electric or hybrid technology. It is therefore an objective criterion for measuring differences in performance between various manufacturers' models. **Real-world driving range greater than 80 km including the most severe use (high load, city centre driving with frequent stops, winter conditions). Actual consumption also depends on the equipment, the driving style of the driver and the elevation profile of the route.

CARLAB Ambiance



CARLAB Equipment and options

	Van	Platform Cab
INTERNAL AND EXTERNAL PRESENTATION		
Side protective moulding/Rear-door protective strip	●	-
Front mud flap/Rear mud flap	○	○
Mini hubcaps / Maxi hubcaps	●/○	●/○
"Z.E. ELECTRIC" rear strips	○	-

OPENING PANELS

270° rear metal doors (L2 and L3 only)	○	-
Right-hand (left-hand in UK) sliding metal side door	●	-

PARTITIONS

No partition	-	●
Full panelled partition	●	○

SAFETY

ABS Braking assistance, ESP Electronic stability program and Hill Start Assist	●	●
3-point seat belts with pre-tensioner	●	●
Front driver airbag*/Side driver airbag	●/○	●/○
Side passenger airbag (requires individual passenger seat)*	○	○
Z.E. Voice: Low speed audible warning	○	○
3-button automatic door locking	○	-
Key with hands-free access (requires automatic locking)	○	○
Sub-frame spare wheel/Inflation repair kit (without spare wheel)	●/○	●/○
Tyre pressure loss warning	○	-

VISIBILITY

Fog lamps	○	○
Manual door mirrors with two sight lines	●	●
Extended door mirrors	-	○
Wide View Mirror	○	○

DRIVING

Height adjustable steering wheel with power steering	●	●
On-board computer	●	●
Cruise control and speed limiter*	○	○
Rear parking sensor	○	-
Reversing camera with screen on the interior rear-view mirror (or on the R-Link screen according to option)	○	-
Engine restriction (70 km/h*, 80 km/h, 90 km/h)	○	○

COMFORT

Manual air-conditioning*	○	○
Automatic headlights and windscreen wiper	○	○

AUDIO/NAVIGATION

	Van	Platform Cab
Plug&Radio with Bluetooth® connectivity and USB socket	○	○
R&Go Radio Connect with Bluetooth® connectivity, 2 USB sockets, DAB compatibility and CD-MP3 player	○	○
R&Go Radio Connect with Bluetooth® connectivity, 2 USB sockets and CD-MP3 player	○	○
Radio Plug & Radio with Bluetooth® connectivity, USB socket and CD-MP3 player	○	○
European maps*	○	○
Renault Evolution R-LINK pack*: R-LINK 7" touchscreen multimedia system, voice control, radio programmed with steering wheel controls, TomTom navigation, audio streaming and Bluetooth® hands-free telephone system, USB and jack ports, vehicle connectivity (also available with terrestrial digital radio)	○	○

STORAGE

2 x 12 Volt sockets on the dashboard	●	●
Cover on dashboard	○	○
Retractable shelf in dashboard	○	○
Fixed shelf on seat backrest (requires passenger bench seat)	●	●
Rotating shelf on seat backrest (requires passenger bench seat)	○	○
Under-seat storage boxed-in with tilting backrest (requires passenger bench seat)	○	○

LOAD SPACE

Floor anchoring points / Body side anchoring points	●/○	-
Anti-slip floor protection*	○	-
Mid-height side protection*	○	-
12-volt outlet in loading area on rear pillar	○	-

SEATS

Driver's seat with lumbar adjustment and armrests	●	●
2-seater passenger bench seat	●	●
Individual passenger seat	○	○
Imitation leather upholstery	○	○

CABLES

Wallbox cable 32 A	●	●
Domestic cable 10 A	○	○
Green Up cable 14 A	○	○

● = Standard; ○ = Optional; - = Not available. *To go on sale at a later date

CARLAB Dimensions

PLATFORM CAB

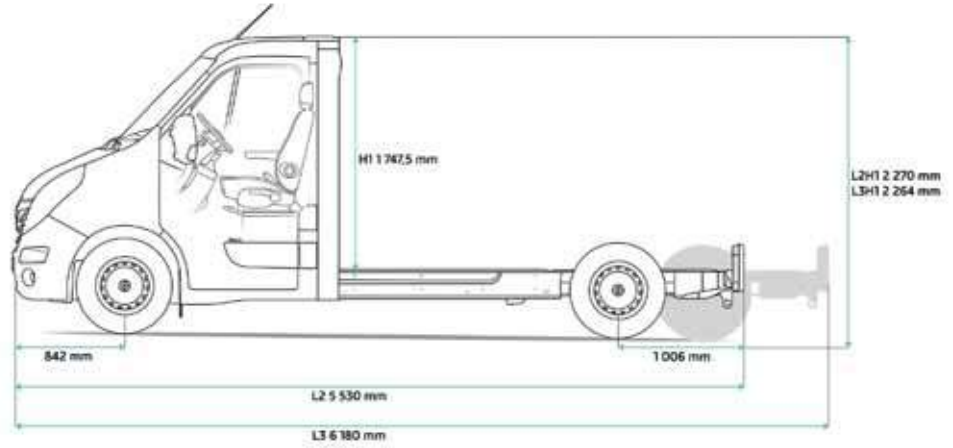
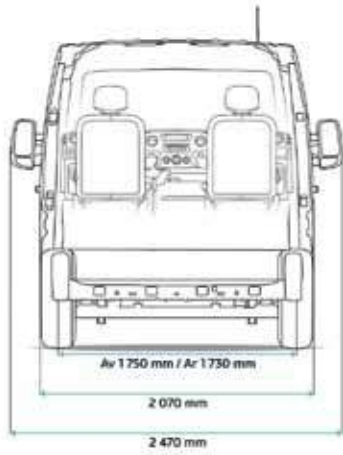

VAN

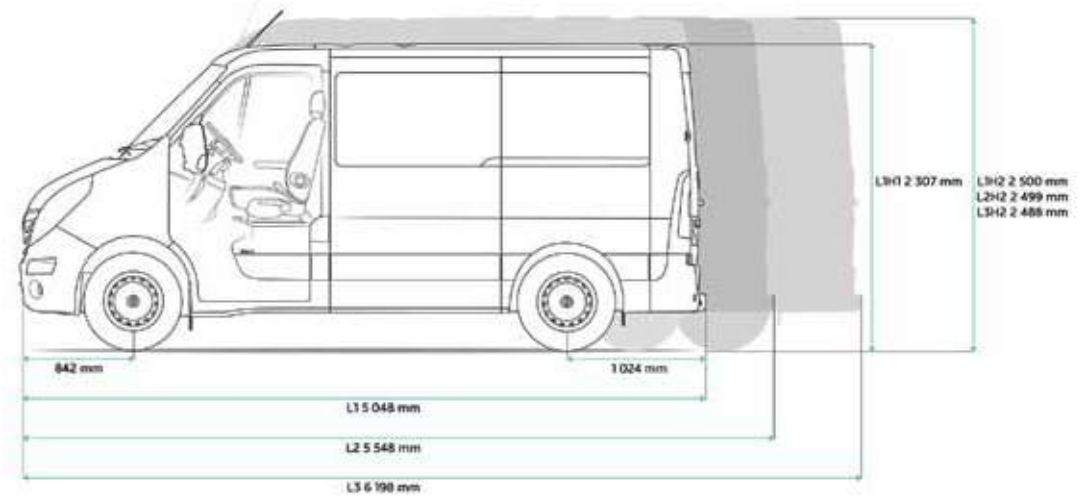

BATTERY RENTAL

The battery rental guarantees you complete peace of mind: Renault assures the quality, performance and complete life cycle of the battery, from its manufacture to its recycling.

- Your battery lease means you are guaranteed a battery that is in perfect working order at all times, with sufficient charge on it, always above 75% of its initial capacity.
- The rental cost depends on your mileage. You and your Renault adviser will select the package that is best for you, equivalent to your usual fuel budget.

• You don't have to worry about a price reduction for the battery when you resell your Master Z.E., since you are only reselling the vehicle. When you resell, your battery rental agreement is terminated and the buyer signs a new agreement.

ASSISTANCE

With your battery rental, you also get free comprehensive breakdown cover, including power breakdown (assistance and recovery to your main charging point within a radius of 80 km, 24 hours a day, 7 days a week).

PURCHASING THE VEHICLE AND BATTERY

If you would like to own the battery for your new Master Z.E., now you can! No more monthly battery rental fees. One payment and the battery is yours. The battery comes with a 5 year or 100,000km warranty (whichever is soonest), with a charging capacity

always above 66% of its initial capacity. Breakdown recovery is included during the manufacturer warranty (two years, unlimited mileage).

DRIVING RANGE

Thanks to its new 57 kW motor and new generation Z.E. 33 battery, the driving range of the vehicle is 120 km in real-world use⁽¹⁾. This depends on several variables: route elevation, speed, use of heating and air conditioning, charging / charge conditions and driving style. It is for this reason that we are giving you the means to monitor your range using the on-board instrumentation.

The Econometer tells you your instantaneous power consumption. The "Eco" mode maximises energy recover produced by deceleration and pre-conditioning allows you

to program the heating or air-conditioning of your vehicle via the dashboard while it is under charge, without draining your battery. And remember the good green driving techniques for electric cars: they can save you tens of kilometres.

(1) Real-world driving range greater than 80 km including the most severe use (high load, city centre driving with frequent stops, winter conditions).





Renault Master Z.E.
100 % Master / 100 % electric